



OWNER'S MANUAL YETI SB100

TABLE OF CONTENTS

BRAND OVERVIEW	06
FRAME FEATURES	08
GEOMETRY	10
MAINTENANCE SCHEDULE	12
<i>SETUP</i>	
OVERVIEW	12
SHOCK SETUP	14
DERAILLEUR HANGER INSTALL	18
<i>TECHNICAL</i>	
ASSEMBLY OVERVIEW	22
EXPLODED VIEWS	28
REBUILD KITS	30
<i>LEGAL</i>	
WARRANTY	34
CONTACT INFORMATION	35

CONGRATULATIONS ON YOUR PURCHASE OF A NEW YETI. WELCOME TO THE TRIBE.

We are confident your new bicycle will exceed your expectations for value, performance, and ride quality. Each frameset and component has been custom specified and designed to enhance your riding experience. Whether you are a beginner cyclist, or a seasoned pro, your Yeti bicycle will provide endless hours of two-wheeled fun.

This model specific manual is designed to be used in conjunction with the general Yeti Owner's Manual and the manuals supplied by the suspension manufacturers. If you did not receive the Yeti owner's manual or the manual provided by the suspension manufacturer, download the materials off the Internet, or contact your local dealer.

Bicycling can be a hazardous activity even under the best of circumstances. Proper maintenance of your bicycle is your responsibility and when done properly helps reduce the risk of injury and damage to your bicycle.

Warning: Make sure you review and understand the warnings, instructions, and content of this manual and accompanying manuals for your bicycle.

Warning: Technological advances have made bicycles and bicycle components more complex and the pace of innovation is increasing. It is impossible for this manual or the accompanying manuals to provide all the information required to properly repair and/or maintain your bicycle. In order to help minimize the chances of an injury, it is critical for you to have work performed by an authorized Yeti retailer.

This manual outlines basic setup and maintenance recommendations of your new Yeti. Because it is impossible to anticipate every situation or condition that may occur during the assembly, setup, and maintenance of your bicycle, Yeti recommends that all service and repairs be performed by your local authorized Yeti Dealer.

This manual contains many "Warnings" and "Cautions" concerning the consequences of failure to maintain or inspect your bicycle. The word "Warning" indicates a potentially hazardous situation in which, if not avoided, could result in serious injury or death. The word "Caution" indicates a potentially hazardous situation in which, if not avoided may result in minor injuries or damage to your bicycle or a component of your bicycle. Be sure to read and understand all of the Warnings and Cautions listed in the manual.

THE LOWDOWN ON THE SB100 AND ITS FEATURES.

1. PATENTED SWITCH INFINITY SUSPENSION SYSTEM REDESIGNED FOR 100MM OF TRAVEL
2. HIGH MODULUS CARBON FIBER MAIN FRAME AND SWING ARM
3. INTEGRATED 2-BOLT ISCG-05 MOUNTS
4. TAPERED INTEGRATED HEADTUBE (41MM / 52MM)
5. CUSTOM DOWN TUBE PROTECTOR AND CHAIN GUARDS
6. INTERNALLY MOLDED CARBON TUBES INSIDE OF FRAME FOR HASSLE-FREE CABLE ROUTING
7. INTEGRATED AXLE AND DERAILLEUR HANGER SYSTEM
8. BOOST HUB SPACING, FRONT AND REAR
9. CUSTOM SWITCH INFINITY FENDER
10. CLEARANCE FOR STANDARD SIZED WATER BOTTLE INSIDE MAINFRAME
11. UNINTERRUPTED SEAT TUBE FOR COMPATIBILITY WITH LONGER TRAVELED DROPPER POSTS

1. The SB100 delivers 100mm of travel with our patented Switch Infinity Technology that has been redesigned for this short travel frame. Efficient pedaling performance while still smooth and continuous when the going gets rough.
2. Top of the top Turq Series frames and our Carbon series both offer the same geometry and efficiency in all models.
3. The SB100 does away with the front derailleur mount, making it a 1x drive specific frame. This increases stiffness in the frame, making the SB100 one of the stiffest bikes in our lineup.
4. 2 bolt ISCG 05 chain guide mounts are included on the SB100 in case you want to go for some extra drivetrain security for the rowdy sections.
5. The SB100 uses an integrated 41mm / 52mm tapered headset. This system allows for the headset bearings to be contained inside the head tube for an overall lower ride height, more simplified installation, and increased stiffness.
6. The SB100 uses a 37.5mm stroke, 190mm eye to eye Float DPS shock, by Fox Racing Shox.
7. Custom guards on the seat stay, chain stay and down tube keep things quiet while riding and protect the frame.
8. The SB100 features internally molded routing tubes for all cables, making the bike quiet and clean looking as well as reducing maintenance and cable rub.
9. Dedicated 12 x 148 Boost dropouts and integrated hanger with axle threads for strength, stiffness, ease of hanger and wheel installation.

GEOMETRY

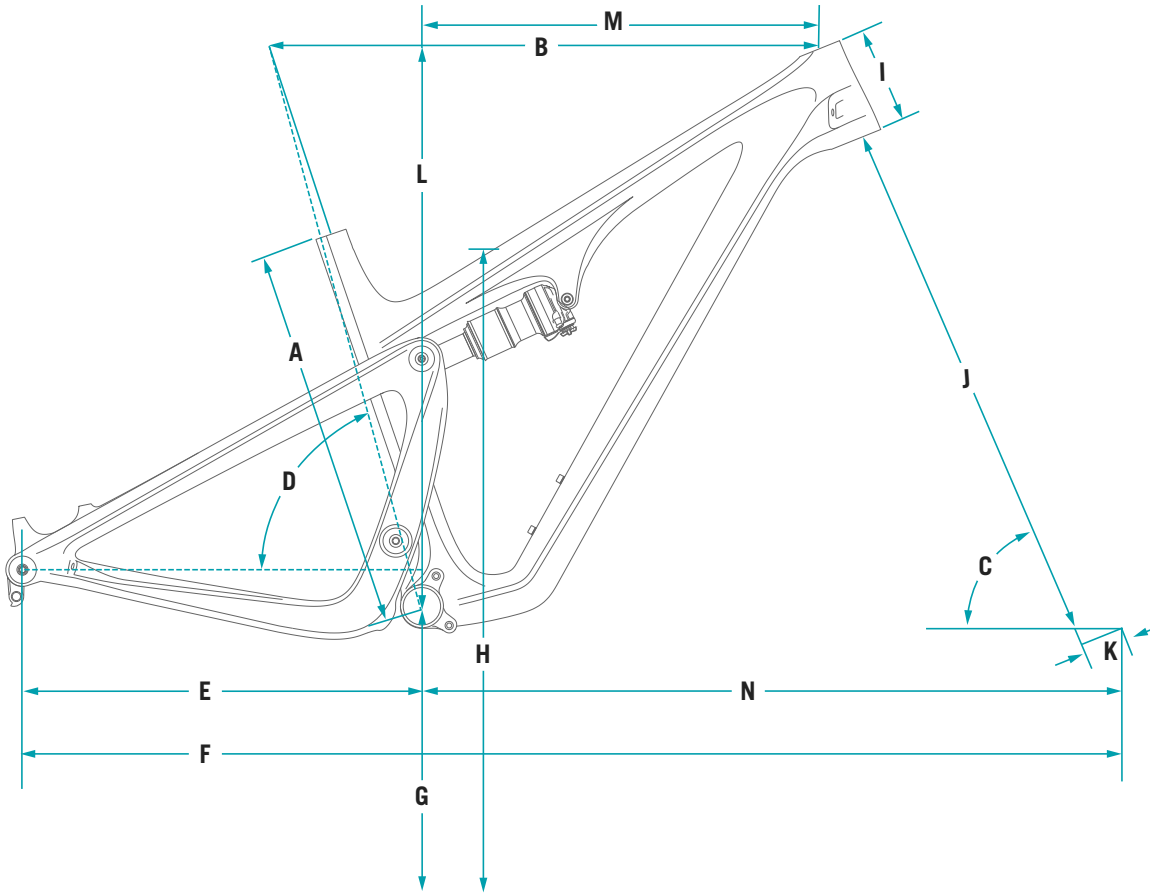

FOX 34 / 120MM FORK

	SM	MD	LG	XL
A WHEEL	29"	29"	29"	29"
B REACH	407.1	432.1	452.1	472.1
C EFF. TOP TUBE	576.7	605.2	630.3	657.2
D STACK	602	612.1	627.1	647.2
E HEAD TUBE LENGTH	96.2	107	123.2	144.7
F SEAT TUBE LENGTH	393	419	457	495
G EFF. SEAT TUBE ANGLE	74.3	74.2	74.1	74
H HEAD TUBE ANGLE	67.8	67.8	67.8	67.8
I MECH. TRAIL	96	95.9	95.9	95.9
J BB DROP	37.9	37.9	38	38
K EST. BB HEIGHT	332.1	332.1	332	332
L CHAINSTAY LENGTH	437	437	437	437
M FRONT-CENTER	685.2	714.2	740.0	768.3
N WHEELBASE	1122.3	1151.4	1177.4	1205.5
O STAND OVER	724	724	723.9	723.9
P AXLE TO CROWN	530.2	530.2	530.2	530.2
Q FORK OFFSET	44	44	44	44

*All measurements are in millimeters

FIT

X-SMALL	4'11" (150 CM) - 5'3" (160 CM)
SMALL	5'3" (160 CM) - 5'7" (170 CM)
MEDIUM	5'7" (170 CM) - 5'11" (180 CM)
LARGE	5'11" (180 CM) - 6'3" (191 CM)
X-LARGE	6'1" (185 CM) - 6'6" (198 CM)

KEEP YOUR YETI FRESH AND CLEAN

OVERVIEW

Following these guidelines will help maintain the performance of your bicycle and prevent more serious problems from arising. It is important to remember that service intervals can vary depending on climate, trail conditions and riding frequency. If you are unsure about working on your own bicycle, contact your authorized Yeti Dealer for more information on general bicycle maintenance.

SCHEDULE	WEEKLY	MONTHLY	3 MONTHS	ANNUALLY
CLEAN AND LUBE CHAIN	■			
CHECK TIRE PRESSURE	■			
CLEAN BIKE OF MUD AND DEBRIS	■			
CHECK BRAKE FUNCTION	■			
CHECK SHOCK PRESSURE		■		
CHECK FOR LOOSE BOLTS AND TIGHTEN, IF NECESSARY		■		
CHECK HEADSET AND TIGHTEN / LOOSEN, IF NECESSARY		■		
THOROUGHLY CLEAN PIVOT POINTS WITH A RAG (DO NOT LUBRICATE)		■		
LUBE INFINITY LINK EVERY 40 HRS. (YETI HEAVY MOLYBDENUM GREASE)		■		
CHECK / REPLACE BRAKE PADS			■	
CHECK TIRES FOR WEAR			■	
CHECK SPOKE TENSION. RETENTION, IF NECESSARY			■	
CHECK CHAIN FOR WEAR. REPLACE IF NECESSARY			■	
COMPLETE TUNE-UP PERFORMED BY AN AUTHORIZED YETI DEALER				■

TORQUE

Yeti strongly recommends using a torque wrench when assembling your frame. Torque specifications for individual parts on the SB100 are listed below, as well as in the step by step assembly instructions later in the manual. For general bicycle maintenance please consult the torque specifications of the component you are adjusting.

KEY TORQUE SPECS

PART NUMBER	DESCRIPTION	TORQUE (NM)
300030295	SHOCK BOLT, 8MM, FLAT HEAD	9
300030057	INFINITY LINK BOLTS (TI STUD 8.0X49MM)	10
200020313	PIVOT HARDWARE, MAIN, 17MM	40
300030294	SS PIVOT BOLTS , 15MM	35
300030293	BOLT, LINK PIVOT, MALE 15MM	8

DERAILLEUR HANGER INSTALL

YETI TIPS

NOTE: The hanger cap is REVERSE THREADED. Be careful not to strip out the Hanger tool faces. The cap is marked with a tighten direction arrow.

Inspect the frame around the hanger seat for any suspicious damage to the carbon any time you replace a derailleur hanger, especially if you are replacing the hanger due to damage to the hanger.

TOOLS NEEDED

- 6mm Allen key
- Grease



01. HANGER PREP

Lightly grease the threads and outside surface of the hanger and cap where it interfaces with the frame. The hanger will fit into its space on the inside of the swing arm and should press easily into the frame.



02. HANGER CAP SEAT

Place the hanger into the recess on the inside of the swing arm. Thread the hanger cap into the hanger. The hanger cap REVERSE threads into the hanger from the outside of the swing arm. Start threading the cap by hand.



03. TIGHTENING

Using a 6mm allen key, tighten the hanger cap into the hanger. REMEMBER, it is REVERSE THREADED. Follow the "Tighten" arrow on the cap. Finish tightening with a torque wrench if available.

**Torque to 80 in/lbs (9Nm)*

SHOCK SETUP

[CLICK TO VIEW SETUP GUIDE](#)

FRAME ASSEMBLY

YETI TIPS

Make sure your tools are in good condition. A worn allen key can round the hex on a bolt not allowing for proper torque.

Torque settings are listed throughout the instructions and on page 13 of this manual. It is important to prep all bolt threads. The instructions denote whether to use a Loctite compound or grease.

Warning: Service on Yeti bicycles requires special knowledge and tools. Yeti Cycles recommends that all service and repairs be performed by an authorized Yeti Dealer

TOOLS NEEDED

- 2.5mm allen key
- 5mm allen keys
- 6mm allen key
- 8mm allen key
- T25 allen key
- Guide pin tool (2)
- Torque wrench
- Cassette tool
- Flat head screw driver
- Grease
- Blue (242) Loctite
- Silver anti-seize



01.

All the parts you'll need to get your SB100 frame assembled. Please refer to the exploded view later in this manual for more information.

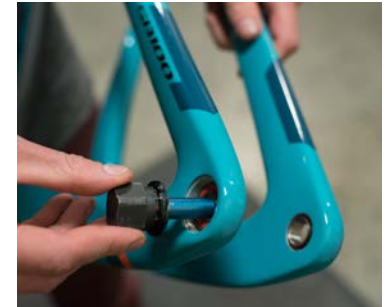

02.

Install 2x Bearing Lockrings (200020311) into the SS Pivots on the Rear Triangle. Tighten to hand tight using a cassette tool.



03.

Install one Grease Zerk (200020314) into each Main Pivot bolt with a flat head screwdriver. Zerk end should be flush with the end of the Main Pivot bolt.

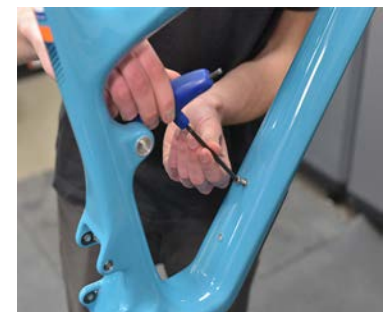

04.

Install 2x H20 Bolts (300030010) and Washers to front triangle.

*Torque: 4 Nm





05.
Push the SB100 Switch Infinity Link into the frame

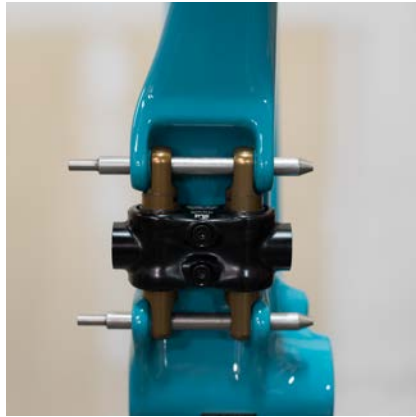

06.
Use a guide pin to line up the shaft eyelet holes with the frame.

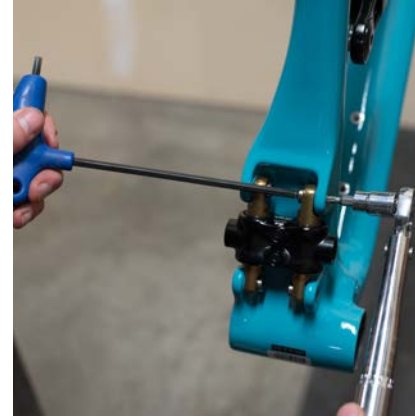

09.
Use a ball-end wrench to prevent the inner Ti Female Bolts from rotating. Torque the 4x Flat Head Ti Male Bolts to **12 Nm**.



10.
Apply a light coat of grease to the shaft of the Female Link Pivot Bolt (300030292). Slide the Alloy Link onto the Front Triangle and install the Female Link Pivot Bolt.

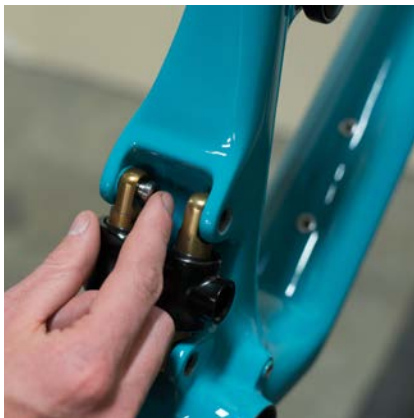

07.
Install a short Ti Female Bolt (300030301) from the inside of the shaft eyelet through the frame. Use a guide pin to help installation if necessary. Repeat for all four mounting holes.



08.
Prep 4X Flat Head Ti Male bolts (300030156) with blue Loctite. Install a Flat Head Male Ti Bolt through the Front Triangle into the Ti Female Bolts. Repeat for all four locations



11.
Grease the threads of the Male Link Pivot Bolt (300030293). Install into Female Link Pivot Bolt.

***Torque to 8 Nm**



12.
Install the rear shock eyelet into the Link. Make sure that the shock controls are facing downwards, and secure with guide pins (note they will not pass through the frame).



ASSEMBLY



13.
Grease heads of 2X Shock Bolt (300030295).
Install Shock Bolt into the rear shock eyelet.

***Torque: 9 Nm**

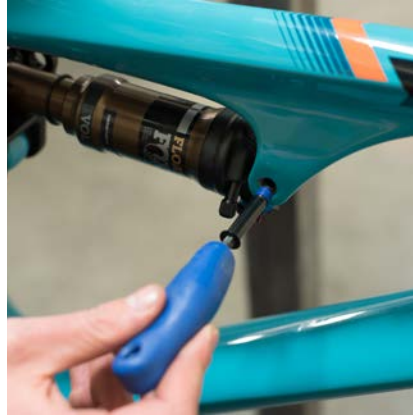

14.
Install front Shock Bolt.

***Torque: 9 Nm**



17.
With a needle-type grease gun, fill grease into the Main Pivot Grease Zerks until a small amount of grease is purged through the Switch Infinity seals. Clean off any excess grease with a clean cloth or rag.

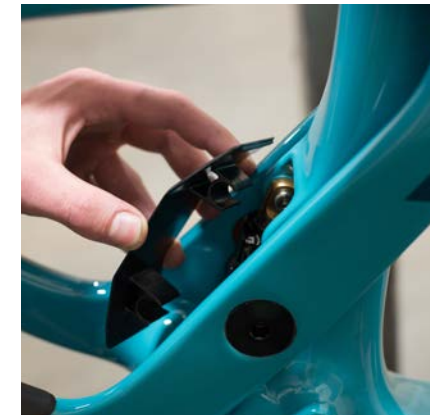

18.
Clip the Switch Infinity Fender (400100194) onto the four switch infinity mounting bolts. Orient the fender so the small raised lip on the backside is at the top.



15.
Slide the Rear Triangle over the Main Pivot onto the Switch Infinity Link. Secure with 2x Main Pivot Bolt (200020313).

***Torque: 40 Nm**

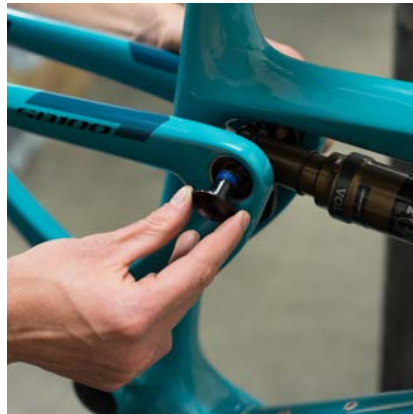

16.
Install 2x Seat Stay Pivot Bolts (300030294) through the Swingarm and into the Link.

***Torque: 35 Nm**

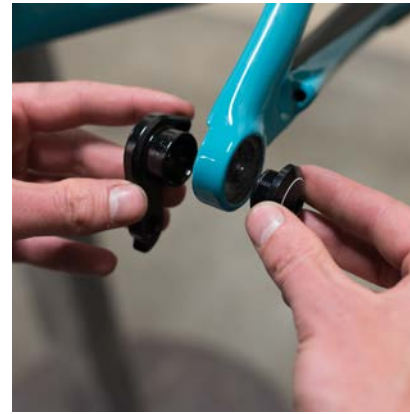

19.
Apply grease to the outside circumference of the Derailleur Hanger and threads of the Hanger Cap (300060073). Install onto the rear triangle. Hanger threads are REVERSE THREADED.

***Torque: 9 Nm**

FRAME ASSEMBLY IS COMPLETE.



EXPLODED VIEW

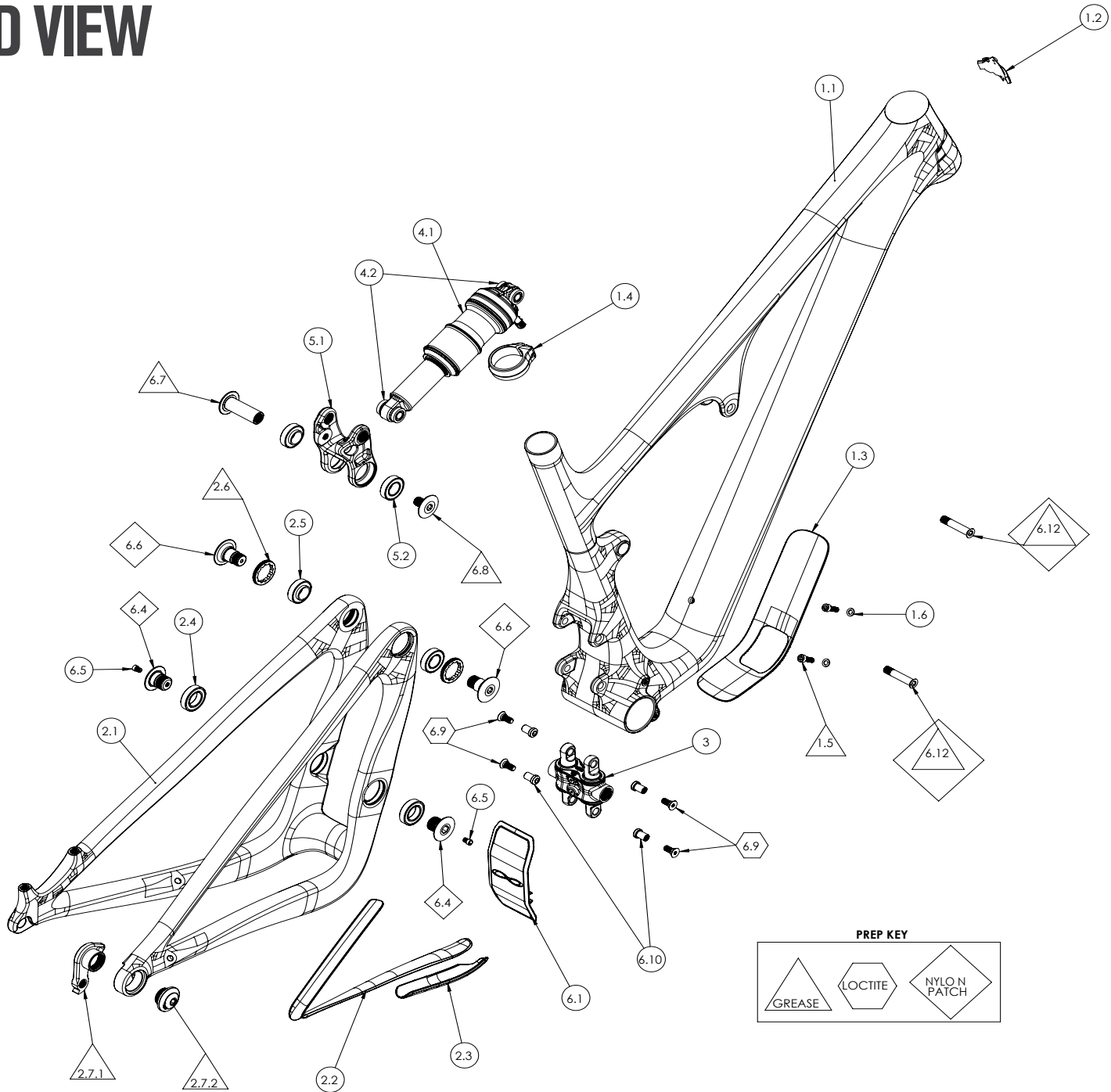

EXPLODED VIEW PARTS LIST

ITEM#	PART #	DESCRIPTION	QTY
1	N/A	SB100 FRONT TRIANGLE ASSEMBLY	
1.1	N/A	SB100 FRONT TRIANGLE	1
1.2	300070006	ICE AXE HEAD BADGE	1
1.3	400100173	SB100 DT PROTECTOR	1
1.4	300060072	YETI SEAT CLAMP STANDARD	1
1.5	300030010	BOLT-CAP H20 (M5 X 0.8 X 16MM)	2
1.6	300030148	WASHER, 5.1X8.9X1MM	2
2	N/A	SB100 SWING ARM ASSEMBLY	1
2.1	N/A	SB100 SWINGARM	1
2.2	400100174	SB100 CS/SS PROTECTOR	1
2.3	400100175	SB100 CS LOWER PROTECTOR	1
2.4	300020001	BEARING, 17X30X7, 6903-2RS MAX	2
2.5	300020052	BEARING, 15X28X7/10 LLU MAX-E	2
2.6	200020311	LOCKRING, SS PIVOT	2
2.7	300060073	12X148 HANGER STD KIT GEN3	1
2.7.1	300060074	12X148 HANGER STANDARD GEN3	1
2.7.2	300060075	12X148 HANGER CAP GEN3	1
3	00787	FOX LINEAR BEARING 74.0MM ASSEMBLY	
4	N/A	SHOCK ASSEMBLY SB100	
4.1	N/A	FOX FLOAT DPS 190X37.5MM	1
4.2	N.A	FOX MOUNT KIT 25.0MM	1
5	N/A	SB100 LINK ASSEMBLY	1
5.1	300040499	SB100 LINK - ALLOY	1
5.2	300020052	BEARING, 15X28X7/10 LLU MAX-E	2
6	N/A	SB100 ASSEMBLY PARTS	
6.1	400100194	FENDER, SWITCH INFINITY INT CLIP	1

ITEM#	PART #	DESCRIPTION	QTY
6.4	200020313	PIVOT HARDWARE, MAIN, 17MM PYRAMID HEAD	2
6.5	200020314	GREASE ZERK, FOX	2
6.6	300030294	BOLT, SS PIVOT, 15MM	2
6.7	300030292	STUD, LINK BEARING, FEMALE 15MM	1
6.8	300030293	BOLT, LINK PIVOT, MALE 15MM	1
6.9	300030156	SHOULDER BOLT, M6X1 FH, TI	4
6.10	300030301	BOLT, TI FEMALE 8.0 X 11.75MM	4
6.11	300030295	SHOCK BOLT, 8MM, FLAT HEAD	2
N/A	100425006	AXLE, YETI BOLT ON, 12X148MM	1
N/A	400100177	FRAME PROTECTOR KIT, SB100 (GLOSS)	1
N/A	400100171	FRAME PROTECTOR KIT, SB100 (MATTE)	1
N/A	300070010	OWNERS MANUAL	1

REBUILD KITS

PART #	DESCRIPTION	QTY
200020316	SB100 MASTER REBUILD KIT	
200020311	LOCKRING, SS PIVOT	2
200020313	PIVOT HARDWARE, MAIN, 17MM PYRAMID HEAD 2	2
200020314	GREASE ZERK, FOX	2
300030301	BOLT, TI FEMALE 8.0 X 11.75MM	4
300020001	BEARING 6903 MAX	2
300020052	BEARING 6902 LLU MAX-E	4
300030156	SHOULDERBOLT, M6X1 FH, TI	4
300030289	BOLT, TI STUD 8.0X49.0MM	2
300030292	STUD, LINK BEARING, FEMALE 15MM	1
300030293	BOLT, LINK PIVOT, MALE 15MM	1
300030294	BOLT, SS PIVOT, 15MM	2
300030295	SHOCK BOLT, 8MM, FLAT HEAD	2
400100176	FENDER, SWITCH INFINITY G2	1
200020317	SB100 BEARING REBUILD KIT	
300020001	BEARING 6903MAX	2
300020052	BEARING 6902 LLU MAX-E	4
400100176	SB100 INFINITY COVER KIT	
400100194	FENDER, SWITCH INFINITY INT CLIP	1

PART #	DESCRIPTION	QTY
200020318	SB100 HARDWARE REBUILD KIT	
200020311	LOCKRING, SS PIVOT	2
200020313	PIVOT HARDWARE, MAIN, 17MM PYRAMID HEAD 2	2
200020314	GREASE ZERK, FOX	2
300030301	BOLT, TI FEMALE 8.0 X 11.75MM	4
300030156	SHOULDER BOLT, M6X1 FH, TI	4
300030289	BOLT, TI STUD 8.0X49.0MM	2
300030292	STUD, LINK BEARING, FEMALE 15MM	1
300030293	BOLT, LINK PIVOT, MALE 15MM	1
300030294	BOLT, SS PIVOT, 15MM	2
300030295	SHOCK BOLT, 8MM, FLAT HEAD	2
400100194	FENDER, SWITCH INFINITY INT CL	1
400100147	PROTECTOR KIT SB100	
400100173	SB100 DT PROTECTOR	1
400100174	SB100 CS/SS PROTECTOR	1
400100175	SB100 CS LOWER PROTECTOR	1
400100179	SB100 PROTECTOR SHEET - GLOSS	1
400100180	SB100 PROTECTOR SHEET - MATTE	1



LIFETIME WARRANTY

HERE'S EVERYTHING YOU NEED TO KNOW ABOUT OUR LIFETIME WARRANTY:

All 2019 (or newer) frames, including the Switch Infinity, are covered for life against damage due to manufacturing defects for the original purchaser. Paint and finish are covered for 1-year. We will repair or replace, at our discretion, any frame we deem defective. There are a few conditions: you must register it online at YetiCycles.com and you must take it to an authorized Yeti Cycles dealer for processing. Warranty does not cover damage due to ordinary wear and tear, neglect or intentional destruction. From a slingshot or your truck.

If you happen to have a crash or non-warranty situation, we'll get you back on the trail with a reasonable replacement price. Same conditions as above.

Lifetime Warranty applies to all 2019 and newer frames (including the SB100). Model year 2018 and older frames will be covered under our previous warranty (5-year or 2-year based on time of purchase).

Simple as that. No fine print.

DISCLAIMER

YETI Cycles is not responsible for any damages to you or others arising from riding, transporting or other use of your bicycle. In the event that your frame breaks or malfunctions, YETI Cycles shall have no liability or obligation beyond the repair or replacement of your frame pursuant to the terms outlined in the warranty.

**If you have a warranty concern, please contact your authorized Yeti dealer.*

YETI CYCLES

621 Corporate Circle, Unit B
Golden, CO 80401
(p) 303-278-6909
(f) 303-278-6906
www.yeticycles.com

BUSINESS HOURS

Monday-Friday
8AM-11:30AM, 1:00PM-5:30PM
(Mountain Time)